



This report is dedicated to all Ukrainians who defend Ukraine, and Europe.

Our heartfelt gratitude to the thousands of our donors in the Netherlands and Belgium, on behalf of the men and women fighting on the front lines and on behalf of Protect Ukraine.



Contents

Our Mission	3
Ambassadors	4
Our Goals	6
Financial Outline	7
Delivered Materials	8
Photo Gallery	9
Initiatives and Partners	17
Dignitas	18
Ground Robot Pilot Schools	20
Mobile Showers	21
Female Drone Pilots	22
Aqua Drone	23
Nebesna Kara	24
Kyiv Rugby Union	25
Kolo-Fly	26
Convoys	27
Bloodbank	28
Tactical Medical Training	29
Brigades	30
Dreamers UA	31
Writers for Ukraine	32
Donors	34
Fast & Cost Efficient	35
After the War	36
Team	37
Volunteers	38
Timeline	40



Our Mission

We focus on supporting the Armed Forces of Ukraine with defensive materials. The Ukrainian defenders are the only ones who can halt the Russian aggression and protect the people.

Method

Protect Ukraine is a fast-track NGO: days or weeks after a request reaches us the materials are at the frontlines. We are in direct contact with brigades and medics in the field, with the TRO and small Ukrainian NGOs. With a dedicated group of about 70 Dutch volunteers, we deliver most of the requested materials directly to Ukraine. We bring tools to defend, plus hope and solidarity to people who need to know they do not stand alone.

Your help

We will continue our work until the Russian aggression in Ukraine is stopped, the damage recovered and (most of) the mines cleared. For our work we are depending on you. We are grateful for that and hope you are willing to continue to support the Ukrainian Armed Forces through Protect Ukraine.



Please visit our website protectukraine.nl for donations and our newsletter, or use this QR code to donate.

The board of Protect Ukraine



Maarten Krijgsman,
Logistics



Dirck Smits van Oyen,
Questor



Zita Jankovich,
Medical



Godfried van Lanschot,
Secretary



Jaap Scholten,
Chair

Ambassadors of Protect Ukraine

"Ukraine belongs to the European family. Europe needs to support Ukraine, now more than ever. Protect Ukraine sets an example on how to act."



Kajsa Ollongren,
Deputy Prime Minister of the Netherlands (2017-2022), Minister of the Interior and Kingdom Relations (2017-2022), Minister of Defence of the Netherlands (2022-2024).

"Our freedom and our values are too important to leave to our politicians. Every individual has to stand up against evil and war."



Alexander Ribbink,
Tech investor, General Partner at Keen and currently raising a dedicated European Defence Tech investment fund.

"We have to support the brave Ukrainians who fight for the freedom of us all."



Alexandra Jankovich,
McKinsey & Co. Founder of SparkOptimus, supporting leaders globally with digital and AI transformation. Co-founder of Refugeehelp and Refugeework to support (Ukrainian) refugees.

"The war in Ukraine is a flagrant violation of the international rule of law. The free world must stand with the brave Ukrainians and resist Putin's delusional ideas about the return of the Russian empire."



Dick Berlijn,
Former Royal Netherlands Air Force four-star general, he served as Chief of Defence of the Armed Forces of the Netherlands from 2004 until 2008.

"Ukrainians are fighting for freedom, democracy and the rule of law, which we were given as a birth gift and hardly appreciate anymore. The future of liberal democracy seems to be in better hands with them than with us."



Tommy Wieringa,
Award-winning author. For his acclaimed novel "These are the names" he travelled to Ukraine on multiple occasions, which gave him a vivid understanding of the freedom-loving Ukrainians.

"The science of crafting dezinformatsiya is rooted in the Russian identity. Astolpbe de Custine remarked in the 18th century: 'Everything in Russia is deception; Russian despotism reigns supreme in remaking facts. Today this still applies.'"



Han Bouwmeester,
Professor of Operational Military Science at the Netherlands Defence Academy.

“Act, Navigate, Transform, Shape the future (ANTS). The war with axis of evil is winnable. Victory of Ukraine is the best strategy to defend humanity, values and dignity of all of us and de-imperialize russia.”



Dr. Hanna Hopko,
Co-Founder of the International Center for Ukrainian Victory and Chairwoman of ANTS. Former Chairwoman of the Foreign Affairs Committee of the Ukrainian Parliament. One of the civic leaders of the EuroMaidan (2014).

“For 11 years now, Ukrainians have been selflessly defending their democracy, their territory, their freedom and independence. Helping Ukraine in this fight is the sacred duty of all Europeans who believe in democracy, in the rule of law, in the fact that good always triumphs over evil.”



Andrey Kurkov,
Ukrainian author and public intellectual who writes in Russian and Ukrainian. His work is currently translated into 37 languages and published in 65 countries.

“Even if you cannot rely on the international system of peace and security, you can still always rely on people. Ordinary people can change world history quicker than UN intervention. Protect Ukraine is an example of this.”

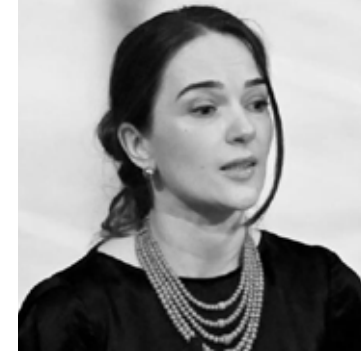

Oleksandra Matviichuk,
Nobel Peace Prize 2022. Human rights lawyer, head of the Centre for Civil Liberties. Since 2014 she researches Russian atrocities in occupied territory. Vice-President of the International Federation for Human Rights.

“Ukraine reminds us of fundamental things such as fighting to protect your family and loved ones, your community, town and country, your freedom...”



Borja de Lasheras,
Senior Fellow at the Centre for European Policy Analysis and former adviser on Ukraine of EU High Representative Joseph Borrell

“Ukraine has no other choice but to remain strong, shielding freedom against tyranny, justice against brute force, national sovereignty against foolish imperial ambitions.”



Daria Kaleniuk,
Ukrainian civil society activist, Executive director of the Anti-Corruption Action Center, Kyiv

“This is not ‘a war in Ukraine’, this is a Russian war against Europe. Therefore, every support of the Ukrainian army and society is so important.”



Volodymyr Yermolenko,
Ukrainian philosopher and journalist, President of PEN Ukraine, Chief editor of Ukrainianworld.org

Our Goals

Protect Ukraine has committed itself to support Ukraine and its Armed Forces until peace returns to the country. The three main goals of our foundation:

1. **Bringing practical tools** asked for by brigades to defend their country. In this we are flexible, we adapt to what the needs are of the military. But for sure we will continue to finance reconnaissance drone production, pilot training, ground robot pilot training and bring 4 by 4 cars, trauma kits, eco flows, stretchers etc.
2. **Bringing hope and solidarity** by traveling regularly to Ukraine, delivering goods to units of the Armed Forces, meeting civilians and military and letting them feel they are not alone in their struggle against the second biggest army of the world.

3. **Documentation and Advocacy.** We strive to keep public attention focused on Russia's aggression in Ukraine and on the danger it poses to all of Europe. Many people in the West seem unaware that this threat affects them as well — and that Ukrainians are fighting on behalf of broader democratic values. While calls for a ceasefire are widespread, what is truly needed is not another armistice that Russia may violate, but a lasting and secure peace for Ukraine. Protect Ukraine firmly believes that long-term peace in Europe depends on a stable and secure Ukraine.

The only chance for Russia to achieve subjugation of Ukraine and Europe is by destabilising and dividing Europe. In its own modest and personal way, Protect Ukraine tries to be a voice against this.



West Ukraine, January 28th 2025, hand over of two ambulances and aid for tactical medical training



Financial Outline

Protect Ukraine was established in May 2022. The donations from May 2022 till May 2025 amount together to € 7.084.805,-, including donations in kind with a value of about € 340,000, mostly medical, donated by Dutch hospitals, and several donated trucks, vans, Landrovers and Range Rovers.

We aim for equal parts of our expenses to be spent on drone pilot training and infrastructure for drones (tablets, starlinks, ecoflows etc.) and cars and protective equipment. A smaller amount is spent on medical supplies and social projects and a tiny amount on communications (website) and administration (bank costs, payment systems). We are working on expanding the medical supply to army units and stabilization points and on training the use of the tactical medical kits. Also the amount of delivered ambulances rose sharply, due to the fact they are now often hunted by Russian drones.

Currently Protect Ukraine shifts more energy and finances to medical aid, with the overwhelming amount of drones in the air, evacuation of the wounded became very difficult. Protect Ukraine works, in cooperation with Ukraine's general staff, on development of a ground robot specially designed for evacuation of the wounded from the Ukrainian frontlines.

Since establishing the ANBI foundation the focus shifted to cars, electric motorbikes, medical supplies, drone infrastructure (needed more than drones, Ukraine's drone production capacity has grown to be sufficient for the moment), pilot training and special projects like the first mobile drone repair workshop in Ukraine.

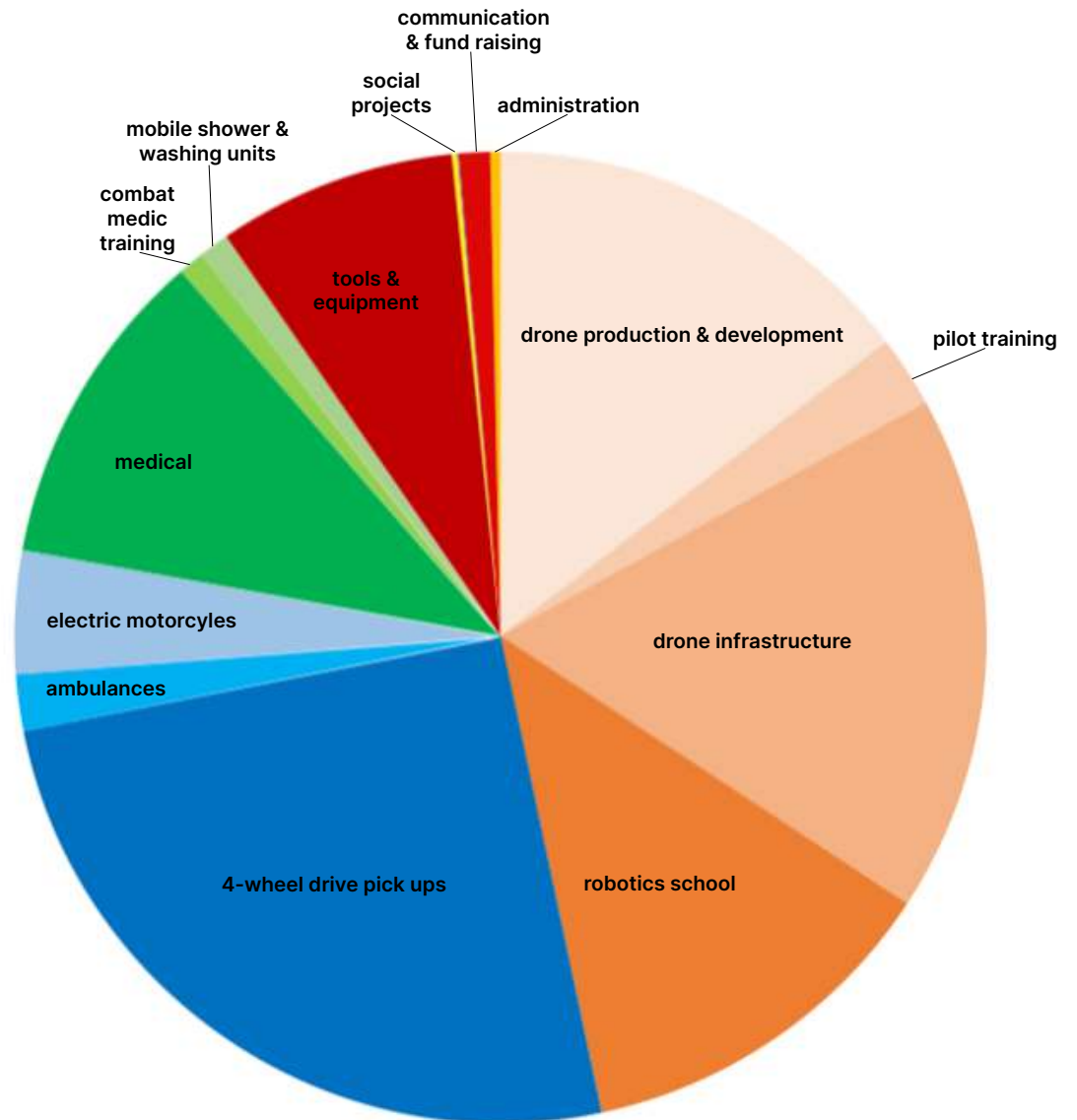

Breakdown of expenditure between May 2022 and May 2025

Delivered Materials

Transport

125 Pick-up trucks
12 Transport vans
12 Ambulances
46 Electric motorbikes
6 Electric bikes
1 Cooling truck for the deceased
1 Rollback truck
1 Argocat

Protection

238 Ballistic vests
238 Plates level IV
366 Kevlar helmets
306 Knee and elbow pads
210 Gloves
110 Goggles
100 Camouflage nets
500 tons Anti-drones fishing nets
10 Tents

Tools

45 Night vision binoculars
1 Tow cable 60 tons
1 Tow cable 90 tons
16 Chainsaws
40 Shovels
3 Crowbars
3 Axes
50 Toolsets
18 Electric drills
12 Water pumps

Medical

2.750 Trauma packs
1.500 Medical supplies
4 Operation room tourniquets
25 Cartridges surgical staplers
28 Stretchers
1 Ilizarov

Drones

3.000 Reconnaissance drones
50 Tablets
23 3D-printers
210 Jammers

Energy

16 Ecoflows
2 Generator 40.000 watt
1 Generator 4.400 watt
9 Generator 2.000 watt
3 Generator 3.500 watt

Other

200 Waterfilters
60 Diesel heaters
25 Walkie-talkies
80 Sleeping Bags
90 Mattresses
2.500 Toe warmers
200 Body bags

Via Dignitas:

Logistics and repair support:

2 mobile repair workshops
6 mobile shower-laundry units
4 vehicles

Technologies and communication:

19 EW systems
13 Starlink
19 charging stations
7 generators
3 engine heaters

Computer equipment and navigation:

2 laptops + 2 monitors
12 tablets

FPV drone components:

GPS modules, antennas, receivers, transmitters
Flight stacks, initiation boards, frames, motors
Control modules, propellers, speed controllers

Drones and equipment:

15 ground control stations for drones
24 masts
38 reconnaissance drones (13 of which are equipped with thermal imaging cameras)
22 FPV-drones
26 antennas
8 controllers
11 FPV-goggles
10 spectrum analyzers



Photo Gallery



Helmets delivered to rugby players on the front lines





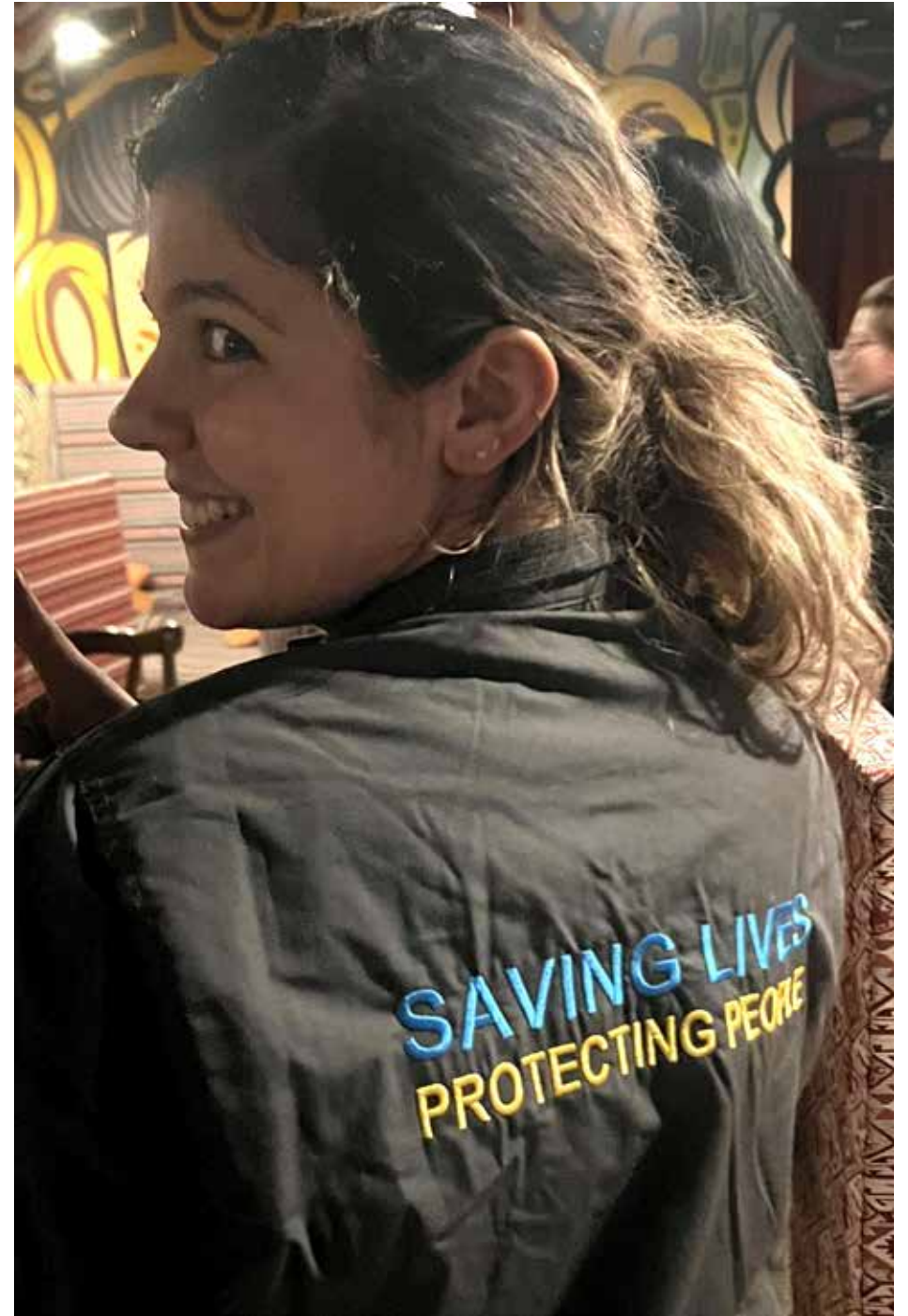







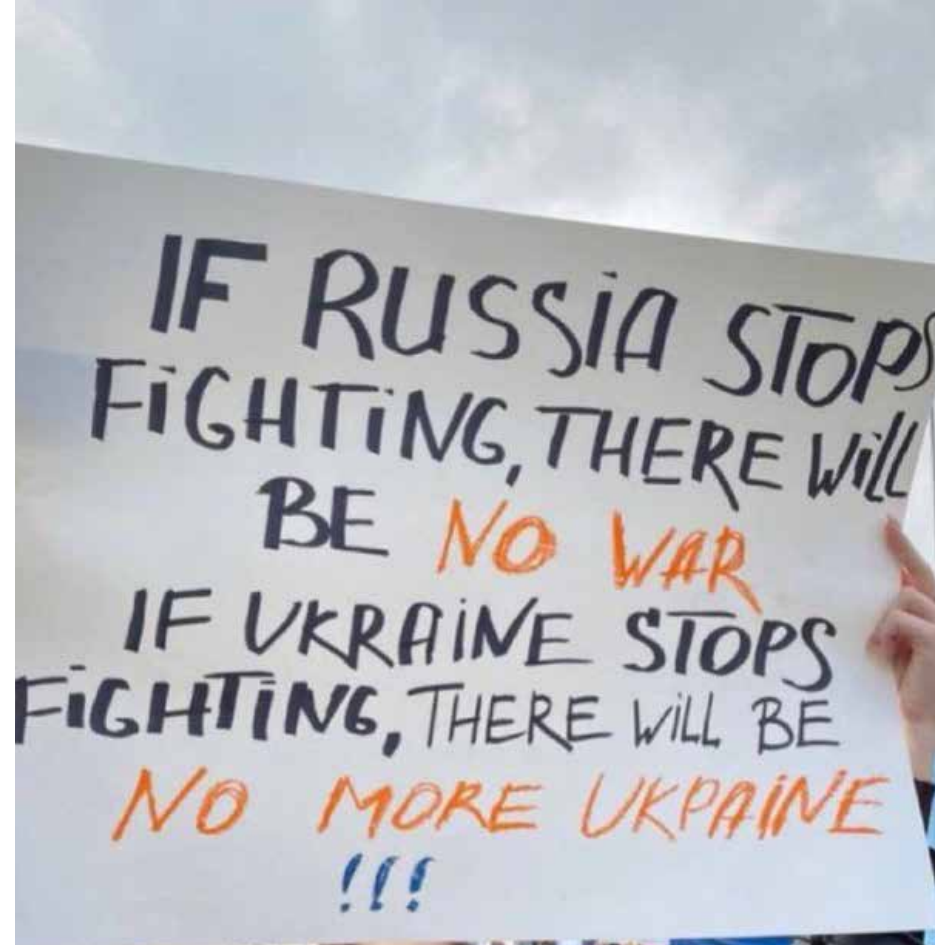

INITIATIVES AND PARTNERS



Dignitas



LtoR: Maria Berlinska, Valerii Zaluzhnyi (former Commander-in-Chief of the Ukrainian Armed Forces), Lyuba Shipovich and staff member of Dignitas.



Dignitas is our dream partner in Ukraine: inventive, state-of-the-art, creative, flexible and highly effective. It is a platform that supports innovation in the army. They are what Protect Ukraine aspires to be: a fast-track NGO and an example of how to support the Armed Forces of Ukraine. We support and work together with Dignitas on many projects, which you find on the following pages. This is how Dignitas describes itself:

Early on, many of us organized fundraisers, mobilized volunteers, and participated in protests to support Ukraine and raise awareness of the Maidan events both in the United States and around the world.

Our volunteers come from diverse backgrounds, many with experience in non-profit work. One of Dignitas Ukraine's co-founders, Lyuba Shipovich, co-founded Razom for Ukraine in 2014, which brought together passionate volunteers in the U.S. and beyond. Since 2013, our efforts have supported Ukraine in a variety of ways:

- *Assisting Ukrainian tech startups in securing investments from U.S. investors*
- *Providing children of fallen Ukrainian soldiers with birthday gifts and educational supplies*
- *Supporting Ukrainian veterans by helping them reintegrate into civilian life through IT and cybersecurity training*



- *Supplying tactical medical gear, including Individual First Aid Kits and medic backpacks*
- *Donating vehicles for medical evacuations*
- *Training and equipping first responders and defenders with quadcopters*

In the fall of 2023 Protect Ukraine started to cooperate with Dignitas, the Ukrainian NGO founded by Lyuba Shipovich and Maria Berlinska. Dignitas is supporting and bringing together the Ukrainian people and military - above all it is an ecosystem for sharing knowledge, sourcing spare parts, drone infrastructure, technological development, training and supporting drone operators and supplying drone infrastructure to the Armed Forces, the State Emergency Service and medical services. They do so in cooperation with the General Staff of Ukraine's Armed Forces.

Inside the first mobile drone repair shop in Ukraine, developed by Dignitas and completely financed by Protect Ukraine.



So far, they have fully trained more than 90,000 drone pilots (more people than the complete French army), the biggest drone pilot educator in the world. Ukraine has the ambition to soon have an army of a million drone pilots, Dignitas is the most important partner to reach this goal. At the 12 training grounds, aspiring pilots receive both theoretical lectures and practice using various technological equipment, including multi-rotor drones, under the supervision of experienced instructors.

One of the branches of Dignitas is Protect - these are the projects done together with and financed by Protect Ukraine. We are proud to help Dignitas support eight brigades with the needed drone infrastructure: Starlinks, antennas, ecoflows, generators, spare parts, etc. Communication systems that hold strong, even under heavy shelling. Mobile workshops keeping equipment battle-ready, right near the front lines. Electronic warfare systems to neutralize enemy drones. Tablets and laptops streamlining command and control.

In 2024, Dignitas together with Protect Ukraine, supported these eight military units:

- 63rd Separate Mechanized Brigade
- 72nd Separate Mechanized Brigade named after the Black Zaporozhians
- 93rd Separate Mechanized Brigade “Kholodny Yar”
- 53rd Separate Mechanized Brigade named after Prince Volodymyr Monomakh
- 110th Separate Mechanized Brigade
- 15th Operational Brigade of the National Guard of Ukraine
- 54th Separate Mechanized Brigade named after Hetman Ivan Mazepa
- 155th Training Center

Dignitas – Ground Robot Pilot Schools

The next important development in this war is the use of ground robots, for evacuation of wounded soldiers and for logistics (to bring water, food, medication, ammunition etc.). We helped Dignitas to establish the first school of ground robot pilots, and we cooperate with the general staff to develop and build a ground robot for evacuation of the wounded.

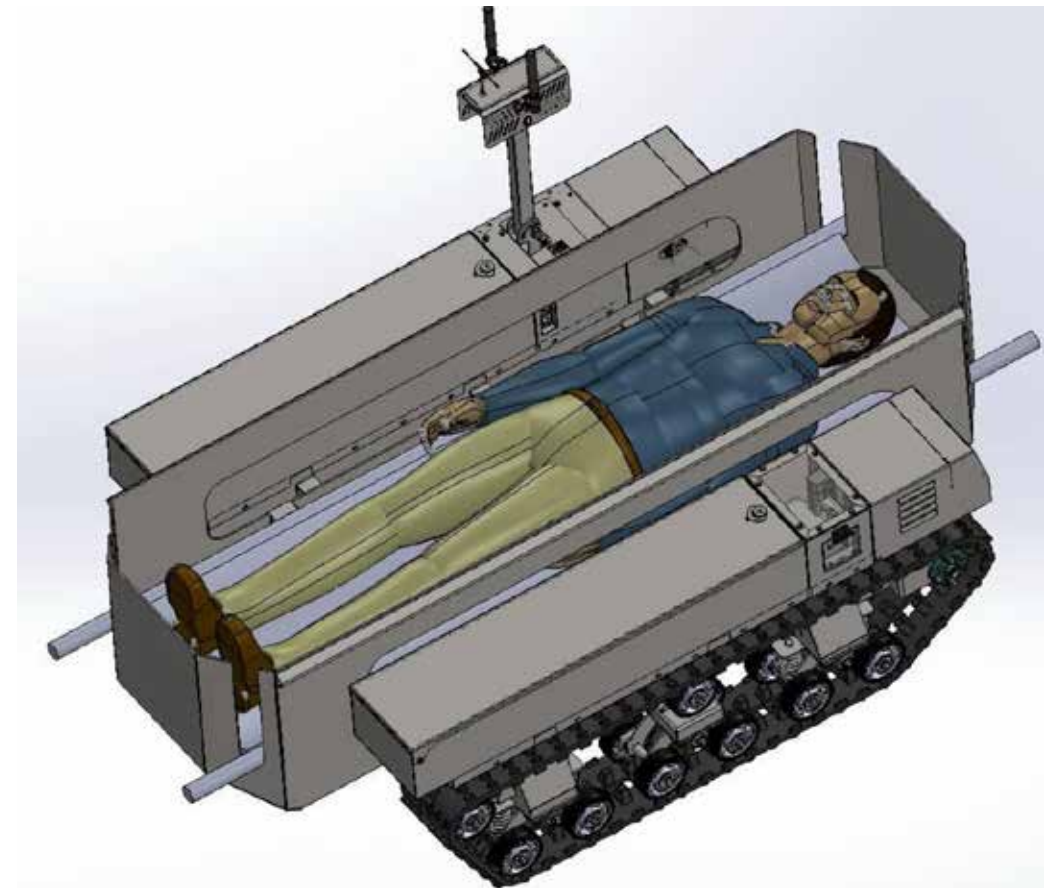

a sketch of one of the first designs of the ground robot



Dignitas – Mobile showers

We support and finance the building of mobile showers and washing cabins, with two washing machines, two dryers, a wood stove, a water tank, a water pump and a generator. Research shows that the biggest source of depression and loss of motivation under soldiers is lack of sleep and the inability to wash oneself.

This is a preliminary list of the units that soon will receive mobile showers:

- 125th Territorial defense brigade
- 53rd Separate battalion of the operational command West
- 20th Separate regiment of unmanned systems
- 411th Separate regiment of unmanned systems
- 92nd Separate Special Forces Brigade
- 93rd Separate mechanized brigade
- 5th Separate mechanized brigade
- 110th Territorial defense brigade
- 47th Separate mechanized brigade
- 25th Separate mechanized brigade

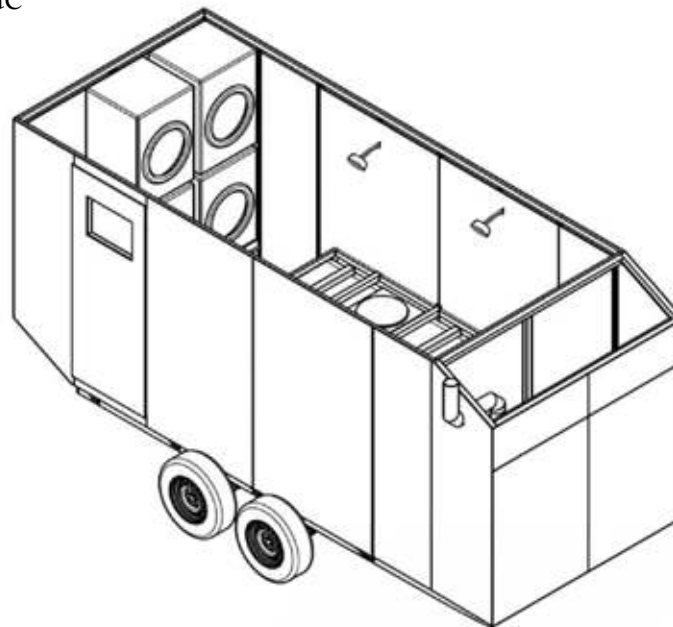
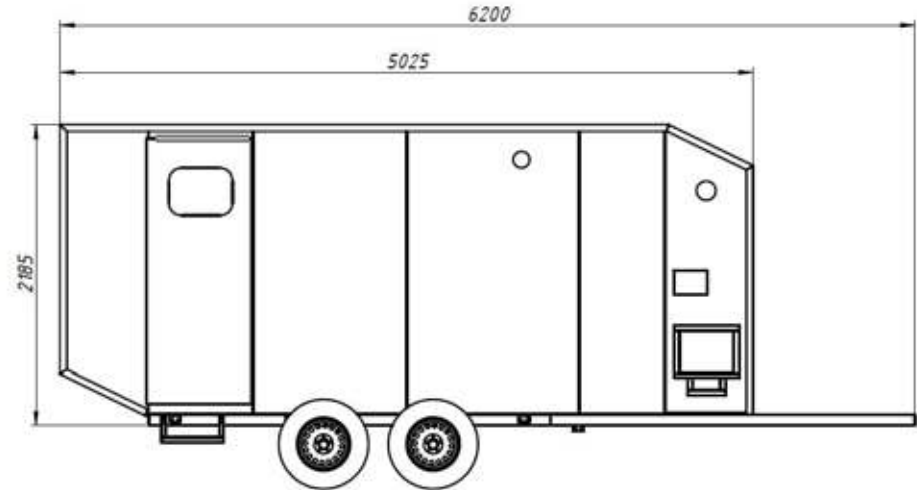

Dignitas – Female Drone Pilots

We sponsor the first special training and equipping of 50 female drone pilots. Military commanders are still protective of their female soldiers and put them often in less dangerous positions like kitchen, administration, and logistics. With Dignitas we try to change that and motivate commanders to send and allow female soldiers to have the training, for that reason they get the complete kit (men do not receive the equipment).





Aqua Drone

On request of the 36th Marines in Kherson Protect Ukraine developed an aqua drone, for logistic tasks as bringing food, water and medical supplies and to evacuate wounded soldiers, as many of the marines are located around rivers and islands.

Our first aqua drone – the GB2 – is currently being tested on the Dnipro by the 35th Marine Brigade in Kherson.





Nebesna Kara

Nebesna Kara (Punishment from Heaven) has been supported by us since March 2022, when a team of drone racers in Lviv decided to dedicate their knowledge to building drones and robots for the army. The man leading the team is a longtime friend of Dirck.

We aided them to set up a workshop which was twice expanded over the past 2.5 years and equipped it with computers, 3D printers and other tools. We support them with the development of de-mining robots and fixed-wing reconnaissance drones that have a speed of 200 km/h.



Today, Nebesna Kara builds around 100-150 fixed-wing reconnaissance drones per month which can fly a distance of up to 70 kilometers behind enemy lines. We supported them to set up a drone pilot school and brought them vans for the pilot school. Recently, Nebesna Kara started to build UGVs (Unmanned Ground Vehicles) for de-mining purposes.

Through them, we supply drone infrastructure, robots used for logistics and fixed wing reconnaissance drones to the 36th Marine Brigade in Kherson, the 28th Mechanized Brigade and the 82nd Air Assault Brigade.



Kyiv Rugby Union

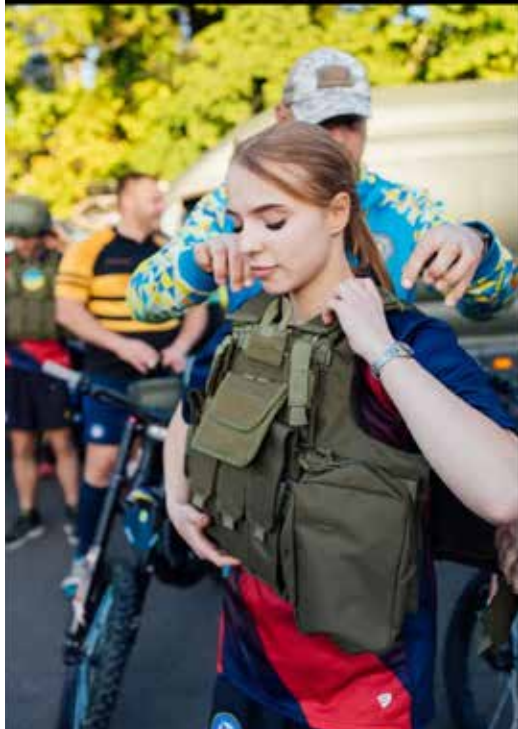

The Kyiv Rugby Union is a perfect, reliable and personal network to support and distribute to individual soldiers and their units. Many of the Dutch volunteers helping Protect Ukraine are former or active rugby players (many from Ascrum (Amsterdam) and from DSR-C (Delft)) so it was obvious to make contact with the Kyiv Rugby Union. Initially, they were suspicious, but after we visited them in Kyiv, a strong cooperation grew from there.

Out of 80 active rugby players of Kyiv's rugby clubs more than 50 are fighting at the front. We support these heroes and their units with cars, electric motorbikes, trauma kits, and protective materials they desperately need. They provide us regularly with precise feedback on how and when the goods are delivered. On Facebook, you can find individual stories of these defenders at [Rugbyplayers4Rugbyplayers](#).



Kolo-Fly

We have worked together with Kolo-Fly since April 2023 supporting their drone development department and pilot school. One of the projects is the Titan, an ambulance drone which can evacuate wounded soldiers from the red and grey zones. Evacuation of the wounded with cars is very hard now, evacuation cars and medics are a prime target for the Russians.

Kolo-Fly has an excellent network of contacts in Ukraine. Through them, we also help units of the Armed Forces with cars, electric motorbikes, generators, medical aid, trauma kits and other requested materials.





Convoys

Our focus has been, starting from March 2022, to bring the Armed Forces of Ukraine what is requested to places where it is needed badly.

Already in March the first transports of helmets, body armor, traumapacks and night vision were transported by Ukrainian volunteers to Kyiv and Mariupol. In May 2022 Jaap drove his first small transport to Kyiv and Chernihiv in a Toyota Hilux loaded with water pumps, drills, chainsaws and other tools. He repeated that twice meanwhile starting Protect Ukraine together with Dirck and friends in May 2022.

In June 2023 Protect Ukraine organized it's first bigger convoy. The SUVs are mostly used by the Ukrainian army as evacuation cars for the wounded and the pick-up trucks often get a machinegun mounted on the back and are used by mobile units to shoot down Shahed drones and protect cities and civilians from drone attacks.

Up till May 2025 we brought about 125 cars, including vans, twelve ambulances, many evacuation cars, one rollback truck, one deep cooling truck for the deceased, an Argocat (for evacuation of wounded through water and mud) and 47 electric motorbikes for reconnaissance and silent logistics. We leave all cars behind for the different units and return by train, taxi, bus or on foot over the border.

The convoys mostly consist of about eight to ten cars, every car with two drivers, so mostly we travel with quite a big group. Driving ourselves is cheaper than transport by truck. By delivering the cars and goods deep into Ukraine we also bring solidarity and hope. It makes the people we cooperate with in the bombed cities and the soldiers we meet realize they are not forgotten by the people in Western Europe. In the winter we bring mostly fresh herring from the North Sea and Bols Jenever plus stroopwafels.



Bloodbank

Protect Ukraine wishes to make a sustainable impact saving lives in Ukraine by improving the quality and quantity of the blood supply. Blood supply services in Ukraine are dispersed throughout the country and patients in need of blood are often forced to look for blood donors themselves.

Even before the war an estimated 2/3 of patients did not receive blood in time or at all. The war, since 2014 and the full-scale invasion of 2022, have made the shortcomings of the blood supply even more evident. The lack of a steady blood supply is a problem for all people, from the mothers giving birth, to cancer patients needing treatment, people who need operations and the soldiers on the battlefield.

PU aims to increase the quantity and quality of blood supply in Ukraine by creating a new blood center in Kyiv. PU works with a Ukrainian partner, Donor UA, and Sanquin in the Netherlands. Donor UA is a price-winning Ukrainian NGO that re-

cruits blood donors. At this point, they have already recruited over 170.000 new blood donors in Ukraine. Now they need a blood donation center.

We will create a blood center which adheres to European and Dutch quality standards. To ensure the quality of healthcare processes Sanquin (the Dutch blood supplier) has agreed to work on this project. They will advise Donor UA and PU on all decisions concerning the quality of the blood supply and train the health care professionals in Ukraine.

We aim to increase the number of blood donations in Ukraine by 5-10% in the first year and up to 40% within 3 to 5 years.

At this point in time, we are focusing on grants from different governments, but we are also looking for other investors. For this project 1,4 million euro is needed. Please contact us if you think you can help in any way with this project.



Tactical Medical Training

Starting from March 2022 we deliver trauma kits to the Ukrainian Military consisting of 1 SOFT tourniquet, 2 Fox seal chest seals, 1 Chitosam hemostatic gauze and 1 emergency (Israeli) bandage. Every soldier, firefighter, policeman or border guard needs to have at least one trauma kit on him/her.

Until May 2025 Protect Ukraine brought about 3000 trauma kits to Ukraine. We also bring stretchers, braces, monitors and other medical essentials donated to us by Dutch hospitals.

Protect Ukraine now supports the tactical medical training of soldiers in West Ukraine.



Brigades

Protect Ukraine works directly with commanders of front-line units to discuss their needs and coordinate deliveries. We focus our support with drone-infrastructure on 6 front-line brigades (see page on the left): the 28th Mechanised Brigade, the 63rd Mechanised Brigade, 72nd Mechanised Brigade, 93rd Mechanised Brigade, 82nd Air Assault Brigade and 36th Marines Corps Brigade are provided with pilot training, jammers and the infrastructure for drone-units like tablets, Starlinks, antennas, Eco Flows etc.

Furthermore, we support many other brigades and units with pick-up trucks, motorbikes and other materials. All these deliveries are made through personal, trusted contacts. To name some: the 13th brigade, the SBU, GUR Military Intelligence, the Border Guard, Special Operations Forces, 12th Special Operations Brigade “Azov”, 79th separate Territorial Defense Battalion, 420 Rifle Battalion, 4002 UAV Strike Unit, 64th Brigade, 91st Brigade, 92nd Brigade, 93rd Brigade, 46th Brigade, 24th Brigade, 25th Brigade, 1st Nordic Tank Brigade, 4th Tank Brigade, 81st Separate Air Assault Brigade, 19th TRO Brigade, 41st Separate Rifle Battalion, 143rd Brigade, TRO 1st Brigade, 119th TRO Brigade. We supplied mini buses for pilot training, a deep-cooling truck for AZOV to bring home fallen defenders and an Argocat for the 3rd Brigade in the Kharkiv region.

ГОЛОВНЕ УПРАВЛІННЯ
РОЗВІДКИ
МІНІСТЕРСТВА ОБОРОНИ
УКРАЇНИ

MAIN INTELLIGENCE
DIRECTORATE
OF THE MINISTRY OF DEFENCE
OF UKRAINE

Бульвар Соєтербек 33, м. Едда, 04176,
тел./факс: (044) 253-07-95, (044) 253-91-90
E-mail: wuy@damba.org.ua, www.gur.gov.ua,
kod armano 1 C2IP 43964883

Elektryky St. 33, Kyiv, Ukraine, 04176,
Tel./Fax: (044) 253-07-95, (044) 253-91-90
E-mail: wuy@damba.org.ua, www.gur.gov.ua,
OH code 43964883

22.04.2024 № [REDACTED]

Stiching Project Ukraine
Soeterbeek 8 5674 NH Nuenen,
The Netherlands

LETTER OF APPEAL/ ЛИСТ-ЗВЕРНЕННЯ

On behalf of the Armed Forces of Ukraine we would like to express the gratitude towards everything the Netherlands have already done and will do in the future to help Ukraine in the war against the unjustified and cruel attack of Russian federation. We fight for our freedom and for the lives of Ukrainian people but at the same time prevent such a catastrophe happening to any other European country and protect the values of the free and democratic world order.

Від імені Збройних Сил України ми хочемо висловити вдячність за все, що Нідерланди вже зробили та зроблять у майбутньому, щоб допомогти Україні у війні проти невинного та жорстокого нападу російської федерації. Ми боремося за нашу свободу та за життя українського народу, але водночас запобігаємо подібній катастрофі з будь-якою іншою європейською країною та захищаємо цінності вільного та демократичного світового порядку.

To improve the efficiency of the execution of tasks by our military unit, we ask for your assistance and help in gratuitous and irrevocable provision to the military unit [REDACTED] pcs of the Talaria Sting electric bikes.

Для підвищення ефективності виконання поставлених завдань нашою військовою частиною просимо Вашої допомоги та сприяння у безоплатному та безповоротному наданні військовій частині [REDACTED] 5 одиниць електробайків Talaria Sting (брошура додається).

Sincerely yours,
З повагою,

Lieutenant General Kyrylo BUDANOV
Chief of the Main Intelligence Directorate of
the Ministry of Defence of Ukraine



Dreamers UA

We support Dreamers UA, an Ukrainian NGO started by Khristina Matvienko. Dreamers UA organizes holiday camps for children of fallen defenders in Transcarpatia. Protect Ukraine helped Khristina to buy food, sleeping bags, tents, camping beds, a tv-screen and audio system.

Dreamers UA also organizes retreats for the widows of fallen defenders. Protect Ukraine also supports these. Thanks to one of our donors, Dreamers UA could now acquire a piece of land in Transcarpatia to build a permanent camp site for the children camps and the widow retreats.

Soon Dreamers UA, together with Protect Ukraine, is going to build lodges on this building site. We still search for materials and support for this great project.



Writers for Ukraine

Advocacy and documentation is one of the 3 main tasks of Protect Ukraine. A group of Dutch writers created the initiative 'Schrijvers voor Oekraïne' (Writers for Ukraine) which performs in theatres throughout the country reading their works on the war in Ukraine. They write books, give lectures and publish articles in Dutch newspapers and weeklies and appear on national radio and television to tell the true and often personal view on the events in Ukraine, as an antidote to fake news and Russian propaganda. The biggest hope for the Kremlin to win this war is focused on splitting the West, destroying our trust in an open, democratic society and our will to fight for it.

The aim is to keep the focus on Ukraine in times when the war is slipping out of people's minds and social media are flooded with misleading information. Most of these authors know Ukraine (and Russia) intimately and travelled with Protect Ukraine as a volunteer to Ukraine.

So far, the group has performed in Winterswijk, Antwerp, Amsterdam (2x), Deventer, Apeldoorn, Zutphen, Enschede and at the Crossing Border and Lowlands festivals. The income from these theatre events is donated to Protect Ukraine. A new series of performances is in preparation. Marcel Wendrich is the organizer of the bigger events. In October 2025 there will be a new series of performances. For information check the 'newsroom' on our website: www.protectukraine.nl





'Schrijvers voor Oekraïne' consists at this moment of the writers Tommy Wieringa, Olaf Koens, Jelle Brandt Corstius, Maurits Chabot, Maarten Doorman, Jaap Scholten, Daan Heerma van Voss, Lisa Weeda, Iris Koppe, and Florian Jacobs, and perform together with musicians Oleg Lysenko, Alex Tugushin among others.



Donors

Protect Ukraine started from zero in 2022 and like many charities was the first year mostly appealing to family and friends for financial support. The response was overwhelming and the Fund grew rapidly in recognition of methods of direct support to the Ukrainian army. Many writers and journalists joined us on the convoys to Ukraine delivering cars and medical aid and writing about their experiences, helping us to generate public awareness for our work and the endurance of the Ukrainian people.

Today, more than 12.500 people supported us with donations of anything between 5 and 250.000 euro. For us all donors are critically important. Without the support of our donors we could not help anybody in Ukraine, but also the more our support-group grows the more influence we can have on media and politics.

On behalf of the Ukrainian soldiers and their families we thank all our donors for their great and generous support.

The Stichting Protect Ukraine is recognized by the Dutch Tax Administration as a so-called ANBI, which means all gifts are tax deductible. Some of our donors even commit by a gift-agreement to donating 5 years, which makes their gifts even more tax deductible.

We hope and trust that this senseless war may end soon. However, the work of our fund will continue long after the war when our efforts will be directed at cleaning Ukraine of mines and supporting rehabilitation and therapy for the military and their families.

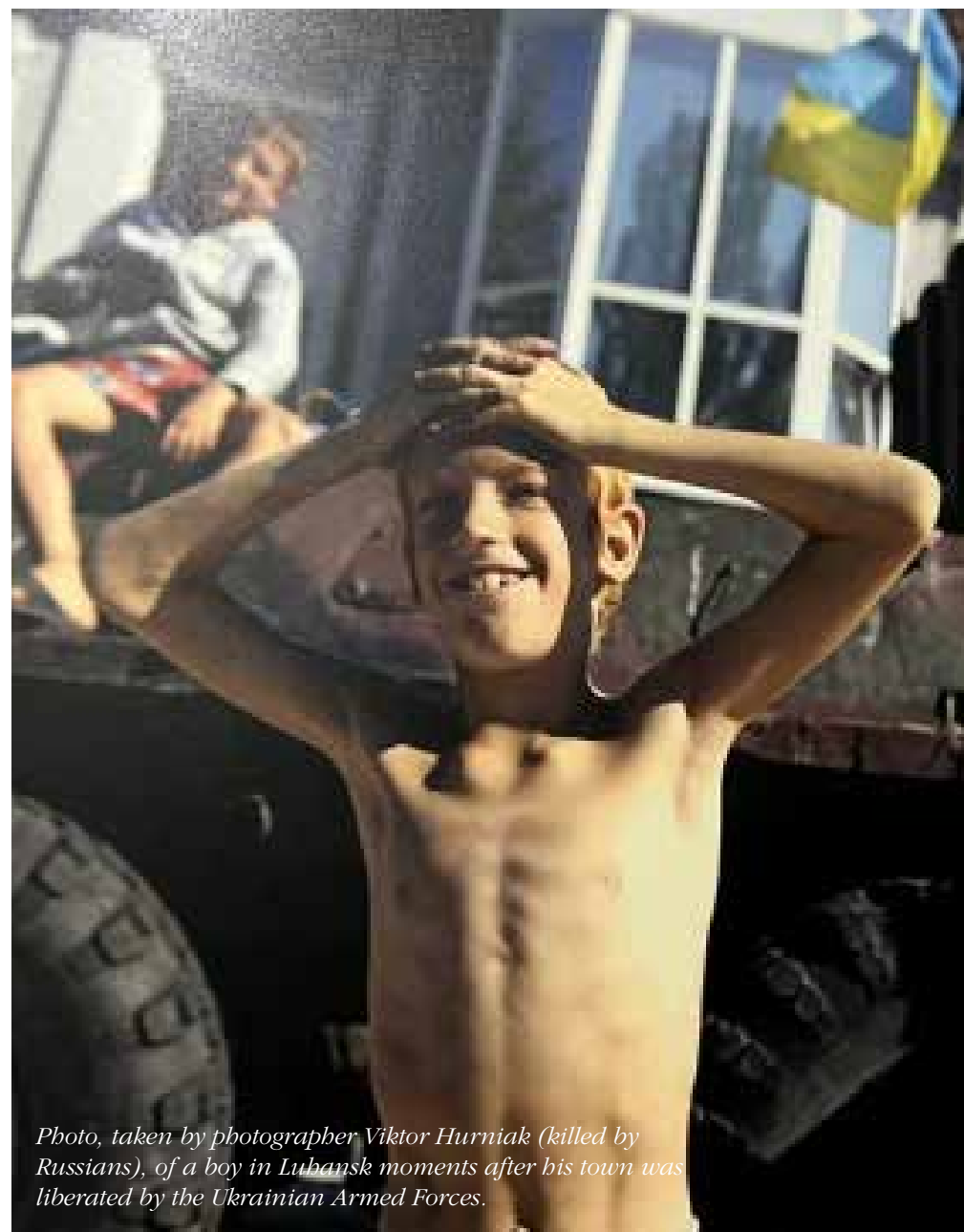

Photo, taken by photographer Viktor Hurniak (killed by Russians), of a boy in Lubansk moments after his town was liberated by the Ukrainian Armed Forces.

Fast & Cost Efficient

The global report 'Passing the Buck, Economics of localizing Aid in Ukraine' published by Refugees International in November 2022:

'Local intermediaries could deliver programming that is 32% more cost efficient than international intermediaries. The localization agenda has seen slow progress globally, with 1.2% of humanitarian funding going directly to local and national actors in 2022. This trend has been echoed in the response to the Ukraine crisis, where 0.07% of funding has gone directly to local actors.'

99% Of all the received funds of Protect Ukraine are used to buy goods which are directed to local partners. Protect Ukraine works 'on demand' directly together with local actors, military and small NGOs and not with ministries, big international NGOs and, in doing so, we are able to deliver fast.

We have chosen eight brigades which we support structurally. We work 'on demand' with people we have met face to face. Dirck Smits van Oyen is on the ground in Ukraine. We keep a paper-trail of delivered goods, try to deliver close to the front and ask for photos and videos of the units receiving our materials.

Protect Ukraine does not pay salaries or fees and most expenses of board members and volunteers are for their own account. The design and website is done by Ukrainians for an extremely friendly price. Overhead costs of Protect Ukraine are minuscule.

We bring cars from the Netherlands to Ukraine, and now also from Lithuania to Ukraine for a much lower price. We do so in collaboration with Ukrainian, Lithuanian and Belarussian volunteers.





After the War

After peace returns to Ukraine, which we hope will happen soon on the terms set by Ukraine, we will continue our support to make the country safe again with a focus on mine clearing and helping the military and their families.

We already cooperate with a small Ukrainian NGO, Dreamers UA, which organizes holiday camps in Transcarpathia for the children of deceased soldiers and the children of the military on the frontlines and retreats for widows of deceased defenders. We provided all tents, mats and sleeping bags which allowed the children to forget for a moment their sorrows and be children again. Thanks to a gift by one of our donors Dreamers UA can now buy a piece of land. We are determined to support Dreamers UA to build a series of huts for the camps.

The need for therapy, both physically and mentally, in Ukraine is, and will be, huge. When the war is over Protect Ukraine will continue to support initiatives in this field using our contacts in the country making sure all efforts go directly to people who need it most and provide feedback on the results.

Furthermore, post-war we will support the huge efforts needed for rehabilitation of wounded or traumatized soldiers and de-mining to make Ukraine's streets, fields and forests safe again.





Team

Support and Advice Group



Thysa Gunning (communications), Bas Westerhout (legal advice), Arjen Joustra (cars), Aart Marcus (aqua drone), Froukje de Jong (medical), Daniel de Rijke (blood bank), Martijn Otten (aqua drone), Sijmen Philips, (Blood Bank, RugbyPlayers4RugbyPlayers), Marcel Wendrich (Writers for Ukraine), Pieter Wesselman (LinkedIn) Joris Barendrecht, Daan Gunning, Jan Petit, Marije Bedaux, Hans Wesseling.

Volunteers

We could not function without our volunteers who spend limitless time and efforts, without any material compensation, to help to prepare and to get materials to the front lines in Ukraine. Like all of us they share the conviction that this battle is as much ours as it is that of the Ukrainians:

Aart, Alexander, Alex, Alina, Andrey, Arjen, Bas, Bengt, Bernard, Carsten, Coen, Daan, Daan, Daniël, Danielle, Desiré, Diederik, Dimitriy, Dima, Dmytro, Florian, Filipp, Farid, Froukje, Hans, Hilde, Hubert, Ilonka, Ingeborg, Ilya, Iris, Jack, Jean, Jesper, Jesse, Jelle, Jozsi, Julia, Julia, John, Jan, Jan Peter, Jan Willem, Jelle, Juliet, Khristina, Lana, Lara, Lex, Liza, Lisa, Lyuba, Maarten, Maarten, Marc, Marius, Maurits, Mees, Michiel, Minze, Maria, Marije, Martijn, Martijn, Oleg, Olaf, Olesya, Oscar, Patrick, Ravenna, Rik, Robbert, Roland, Roos, Santiago, Sarah, Sergey, Sijmen, Shula, Stijn, Taras, Thomas, Tijs, Tommy, Toscha, Willem, Wilco, Wiebe, Wiel, Zita, Zita.



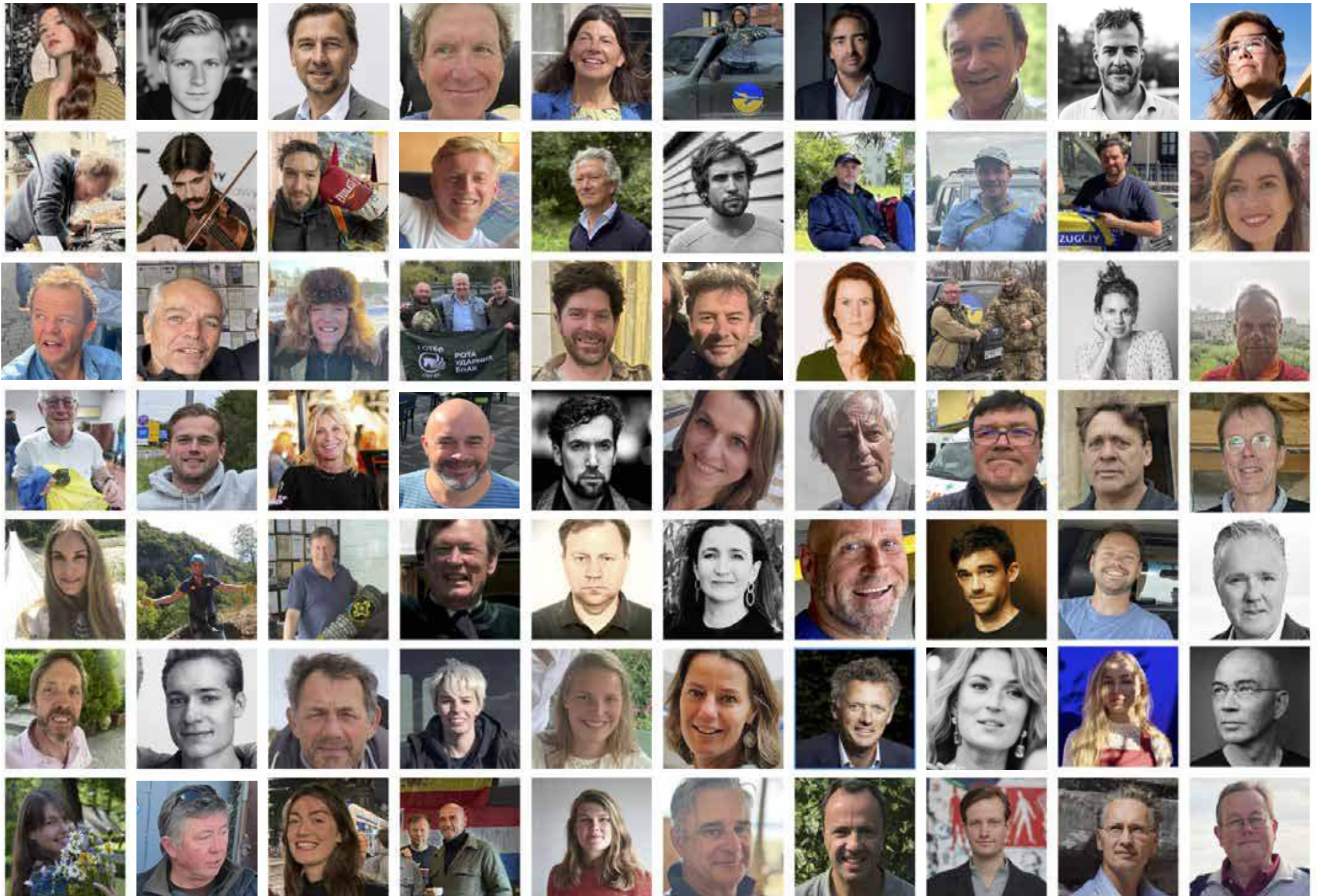

2022



The large scale russian invasion starts, Jaap drives to the border to pick up Ukrainian refugees.

In Hungary, Jaap starts to raise funds for protective gear for the army. Dirck does the same in the Netherlands.

Jaap and Dirck decide to join forces and together with Pieter and Godfried found Stichting Protect Ukraine with ANBI tax status. In the early stage of the full scale war much needed are helmets, vests, drones and trauma kits.

We support the 93rd Mechanised Brigade with drones and other equipment when they liberated Kharkiv province. The 93rd fought in the 2nd battle of Donetsk airport in 2014/15 where they earned the nickname "Cyborgs".

FEBRUARY

MARCH

APRIL

MAY

JUNE



When the russians threaten to encircle Kyiv early March, Dirck leaves Ukraine with his family for the Netherlands.

Dirck supports a team of drone enthusiasts to start the workshop Nabesna Kara (Punishment from Heaven) in L'viv.



Jaap travels solo to Ukraine to deliver tools and tents for the army, described vividly in 'Three bags of ladies clothes & a sniper'.

Generosity of sponsors is overwhelming and soon more than € 370,000 is raised. Hundreds of helmets, ballistic vests, trauma packs and drones are brought to Ukraine.





2022



28th Mech Brigade Robotyne Zaparozhe province receive first batch of recon drones.



We deliver all goods ourselves with the help of our volunteers. Our drone builders we support through specific projects and procuring spare parts.



On September 10th the Ukrainian Army liberates Kupiansk and Izyum. In and around Izyum torture rooms and hundreds of graves were found with tortured and murdered civilians.



On December 5th military targets deep in Russia, including the Tupolev bombers on the Engels airfield and the Ryazan military base, 450 miles from the Ukrainian border, are hit by Ukrainian drones, showing Ukraines growing ability in drone development.

JULY

Jaap makes his third trip into Ukraine to deliver tools to the Military and the Ukrainian Volunteer Army helping in the direction of Kherson.



AUGUST

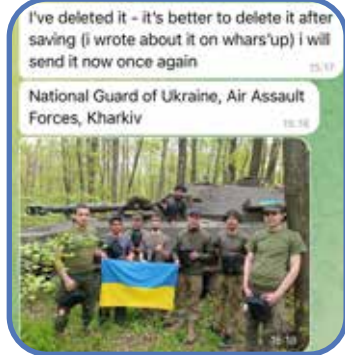

SEPTEMBER

Protect Ukraine supports foundation Ptach to buy materials to produce 100 large camouflage nets for the Armed Forces, made in Poland by Ukrainian refugees.



OCTOBER



NOVEMBER

On November 11th the Ukrainian Armed Forces liberate Kherson, the only big city the Russians captured with the full scale invasion. A city Putin claimed three months earlier to be 'part of Russia forever'.



DECEMBER

2023



On January 17th our friend Dima ("Panama") of the 93rd Mech. Brigade is starring in NOS Nieuwsuur. On February 9th he is killed by a mine in Bakhmut.



In the winter of 2022 the Armed Forces asked for ecoflows, heaters and generators, in early spring of 2023 the biggest request is for cars and reconnaissance drones.

It was a question how he sees the ending of the war. He said we are gonna loose a lot of people, a lot of kids, women and men, it's gonna be very cruel and long fight, but at the end of the day we're gonna have our territories and freedom back. We don't even believe in victory, we just now it's gonna happen



Protect Ukraine organised a charity piano concert in Amsterdam by the Ukrainian super talent Anna Nebaba.

JANUARY

FEBRUARY

MARCH

APRIL

MAY

JUNE

In Amsterdam's 'Pakhuis de Zwijger' Protect Ukraine organises, together with Oscar van Gelderen, an evening to remember one year of full scale war with Olaf Koens, Jelle Brandt Corstius, Iris Koppe and others.



Protect Ukraine finances 6 cars for the Armed Forces fully loaded with humanitarian goods in a convoy by Angels for Ukraine.



82nd Mechanised Brigade near Verbove, Zaparozhe province starts receiving drone infrastructure.



Those two cars will go straight to the 0 lines, somewhere near Bakhmut, my dad got the passwords to get there cause there is no other way and I promise you he will take a lot of pictures

Thanks. Do you know the units?



Destruction of Kakhovka Dam on June 6th by Russian army: an humanitarian and ecological disaster. Protect Ukraine brings for Military and civilians 200 water filters.



Protect Ukraine's first larger convoy brings 7 cars fully loaded with ballistic vests, helmets, trauma kits and much more to the Armed Forces of Ukraine.



Several famous Dutch authors joined the convoys to deliver goods to Ukraine and published their experiences in books, newspapers and at public events in the Netherlands.



Protect Ukraine starts cooperation with the Kyiv Rugby Union. Through rugby players at different units we provide helmets, vests, trauma kits, motorbikes and cars.



The UAV unit of the 63rd Mechanised Brigade located next to Lyman in Donetsk province is supplied infrastructure equipment.

JULY

AUGUST

SEPTEMBER

OCTOBER

NOVEMBER

DECEMBER

For the third time Protect Ukraine gets a message from an Ukrainian military that his life was saved by the gear they provided.



The second convoy with 12 cars and humanitarian goods is delivered to Ukraine and partly handed over to the 36th Marine Brigade.



The 35th and 36th Marine Brigades of Ukraine establish a bridgehead at Krynky at the East shore of the Dnipro. Pick-up trucks delivered by Protect Ukraine are used to transport the boats to cross the Dnipro river.



Total donations in 2022 and 2023 reach € 1,2 million.



2024



We fully equipped a UAV team of the 72nd Mechanized Brigade, aka the Black Zaporozhian Cavalry Regiment, based in Vuhledar in Zaporozha province.



A delegation of Protect Ukraine in company of Andrey Mahomet of the 36th Marine Brigade visits the Dutch Parliament and speaks with Defence specialists of seven political parties including the by now Minister of Defence Brekkelmans.



Jaap commemorates the strikes of April-May 1943 (the largest strikes in Europe against Nazi-Germany) and links the fight against fascism in the 20th and 21st centuries: "The greatness of small acts of resistance".

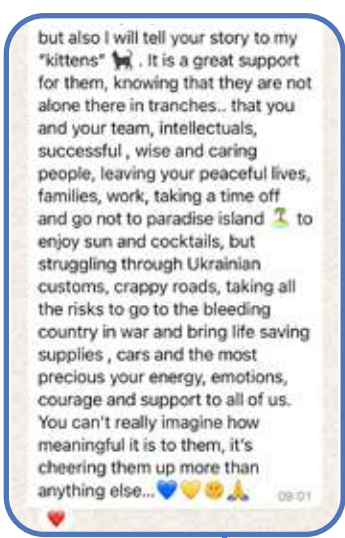

JANUARY

FEBRUARY

MARCH

APRIL

MAY

The third convoy of cars and goods delivered all the way to Izyum, 30 km from the front line. Protect Ukraine starts to collaborate more intensive with Dignitas after visiting them in Kyiv.



The drone department of the 63rd Mech. Brigade is expanded; we supplied their repair shop near Lyman with spare parts for reconnaissance drones.



The fourth convoy including 25 electric motorbikes delivered to Ukraine with cars for the 63th Mechanised Brigade and others.



2024



Mon, 8 Jul

Dear Jaap,
 I hope you are doing well. Today my region in Kyiv was attacked by Khinzhal. The children's hospital was targeted. There are 10 victims already confirmed, the accesses to the basement where children and medical personnel were hiding during air attack cannot be reached. The rescue teams and volunteers are working to find survivors. The voices are heard from collapsed buildings. These violent attacks by russia are forcing us to negotiate and obey putin's requests. Ukrainians will never accept them and we are more focused and more united. The only way to save civilians is to support our Armed Forces. Therefore, I am addressing you for help, the Third Brigade, where many bandero rugby guys are surviving (for detailed information you may check with Andriij) desperately needs Argo Avenger and Argo AURORA for medical evacuation of wounded combats and civilians.



July 8th, Russia's targeted attack on the Okhmatdyt hospital (Ukraine's largest children's hospital) with an Kh-101 cruise missile.



Protect Ukraine invites its volunteers, larger donors and everybody who helped to celebrate Ukraine's Independence Day on August 24th.



The Protect Ukraine Rugby Team delivers cars and electric motorcycles to the Kyiv Rugby Union and plays the first international tournament in Ukraine since the full scale invasion.

JUNE

The second holiday camp for children of active and fallen defenders in the Transcarpathian mountains, partly financed by Protect Ukraine.



JULY

August 6th, the Armed Forces of Ukraine launch an incursion into Russia's Kursk Oblast.



AUGUST

The fifth large convoy of Protect Ukraine, bringing 10 cars, 15 electric motorcycles and 400 trauma packs, including the goods we deliver in person to the 80th Air Assault Brigade in the Sumy region.



SEPTEMBER

During the many air alarms a lucky encounter with historian Timothy Snyder in the shelter of a Kyiv hotel.



OCTOBER

2025

The authors connected to Protect Ukraine gave a series of readings and talks in the start of 2025. Medic Khristina joined them for five performances in February.



The 24th of February marked the third anniversary of the full-scale invasion. Member of Parliament Jan Paternotte, Defence Minister Ruben Brekelmans, Jaap Scholten, and Khristina spoke at Dam Square to commemorate this day.



Youngsters against tyrants

For the first time, a Protect Ukraine convoy of young volunteers drove eight cars, loaded with medical supplies, from the Netherlands to Ukraine.



Golf players of Ruf & Bluf of the Royal Haagsche Golf & Country Club donated four cars to Ukrainian rugby players, marking the 125th car donated.



DECEMBER

JANUARY

FEBRUARY

MARCH

APRIL

MAY



We drove a van full of sleighs to the winter camp of Dreamers UA, for children of fallen defenders.



In January, part of the board of PU (Maarten, Dirck and Jaap) met with Deputy Commander-in-Chief Andrii Lebedenko, together with Maria Berlinska and Lyuba Shipovich of Dignitas.



Convoy 7, consisting of 4 ambulances, 5 off-road vehicles and 1 lorry, delivered supplies to the military hospital and to the 80th brigade in Sumy. In the old town centre of Sumy, a local graffiti artist repainted our lorry to camouflage the red cross.



On 13 April 2025, Russia launched a missile strike in the old city centre of Sumy that killed at least 35 people, including two children. It was the deadliest attack on Ukrainian civilians since 2023.



БОРИХ В СЬКІИ

БЕРАЯ СЬК

КАТРАС

И ДЗІ НЕ ЗІА





